

Spare Parts

Foam- Injector ST-60.1

Item-No. 20 0060 700

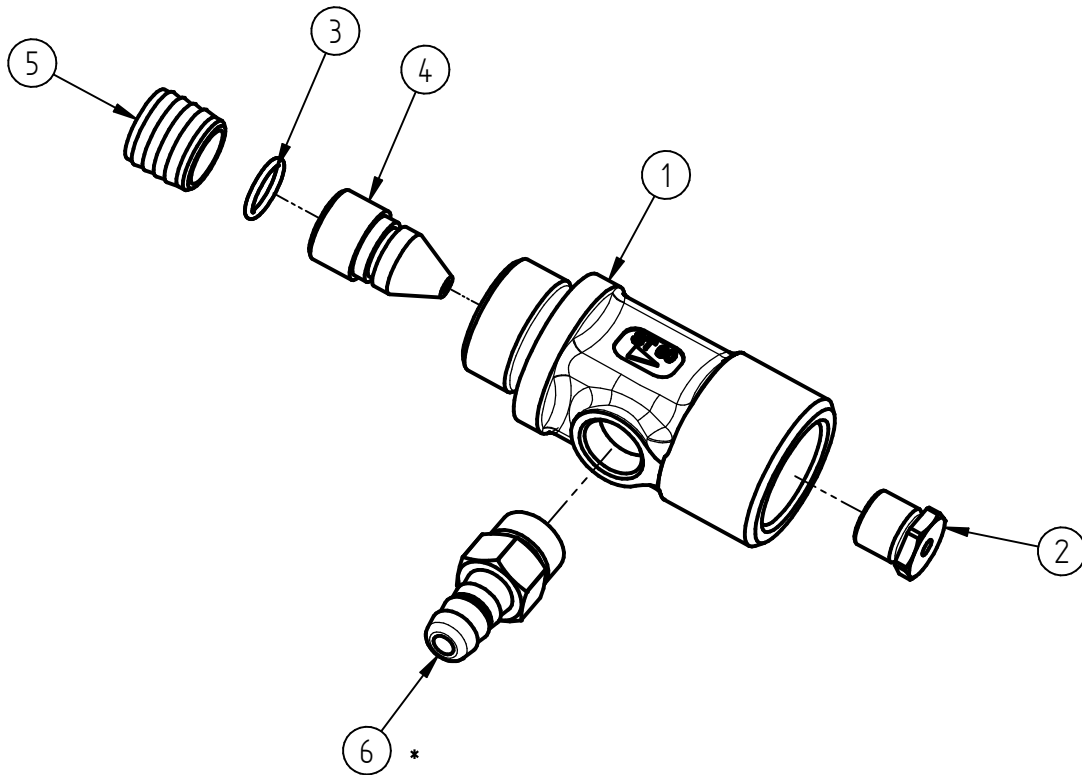

Pos.	Item-No.	Description
1	01 0001 590	Housing
2	04 0002 690	Opposed nozzle
3	05 0000 360	O-Ring 7x1
4	04 0002 700	Nozzle 1,6mm
5	02 0002 590	Hub
6	20 0060 720	Hose nozzle + check valve

Repair-Kits

Pos.	Item-No.	Description	Pos.	Item-No.	Description
*	20 060 725	Repair-Kit Check valve			