



- Coin box easywash365+ including control box..... 84
- Motor control easywash365+ 84
- Motor protection switches 82
- Ravel motors 83
- Remote thermometers 82
- Remote thermostats..... 82
- Time hour meter 82

Motor protection switches

Type OKN



K F

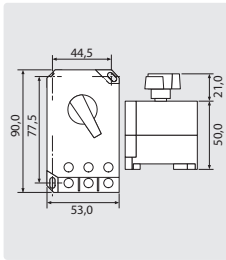

Housing for type OKN

R+M Nr.	working range
901 516	10.0 - 16.0 A
901 522	16.0 - 22.0 A
901 527	22.0 - 27.0 A

R+M Nr.	(M)
901 540	plastic

Time hour meter



cutout

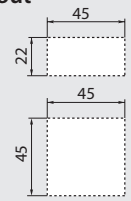

Meter with clip

R+M Nr.	(V)
915 102 4	24 V ~
915 122 0	230 V ~
915 140 0	400 V ~

Remote thermometers

With contact probe and adjustable knob

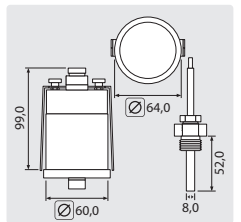

1/2" M. Contact 5 A - 250 V (AC1). Indication of temperature 0 - 120 °C

R+M Nr.	working range	tube length
910 20	0 - 80 °C	1,000 mm

Type WIMEX

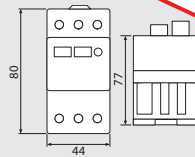

new



new

Housing for type WIMEX, IP55

R+M Nr.	working range
901 710	6.3 - 10.0 A
901 716	10.0 - 16.0 A
901 720	16.0 - 20.0 A
901 725	20.0 - 25.0 A

R+M Nr.	(M)
901 730	plastic

Remote thermostats

Emerson 1536

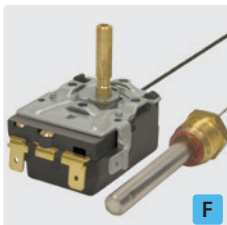

F

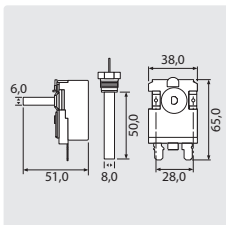

M14 x 1 M. Contact 16 A - 380 V (AC1)

R+M Nr.	working range	tube length
910 16	0 - 160 °C	1,550 mm

Probe with screw

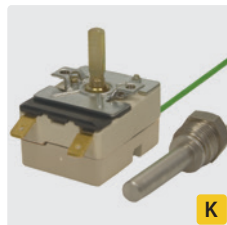

K

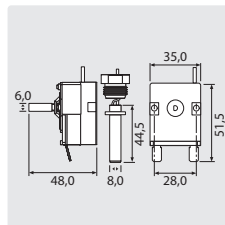

3/8" M. Contact 16 A - 380 V (AC1)

R+M Nr.	working range	tube length
910 12	30 - 150 °C	1,520 mm
910 13	0 - 152 °C	920 mm

Emerson 8654



W

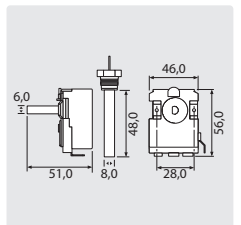

3/8" M. Contact 16 A - 380 V (AC1)

R+M Nr.	working range	tube length
910 15	30 - 150 °C	1,550 mm

Probe pocket PS1



new

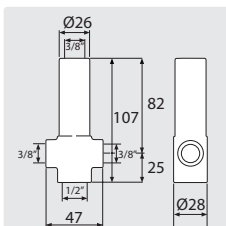

Brass. Max. 280 bar / 160 °C

R+M Nr.
178 290 260 35

Ravel motors

Motor with hollow shaft

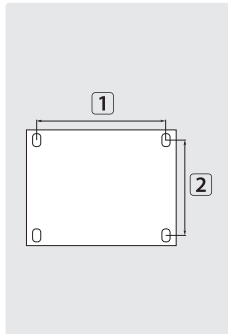

IP54. 1,400 r.p.m.

R+M Nr.	∅	hole size 1 x 2	TYP	V	A	KW
175 001 061	24	140 x 160 mm	H100	400	6,9	3
175 001 081	24	140 x 190 mm	H112	400	9,4	4
175 001 090	24	140 x 190 mm	H112	400	12,1	5,5
175 001 120	24	140 x 216 mm	H132S	400	15,4	7,5
175 001 143	24	178 x 216 mm	H132M	400	21,3	11

Motor with solid shaft

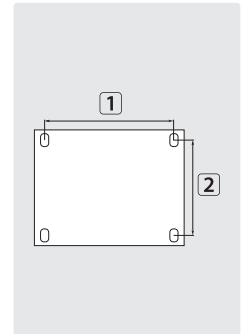
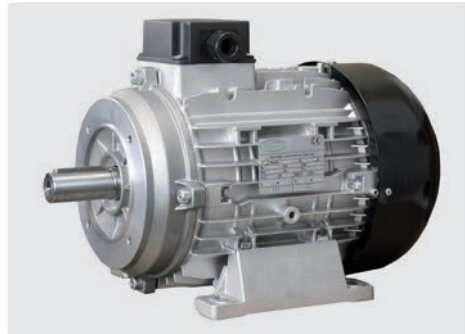

IP54. 1,400 r.p.m.

R+M Nr.	∅	hole size 1 x 2	TYP	V	A	KW
175 002 004	28	140 x 160 mm	H100	400	5,1	2,2
175 002 001	28	140 x 190 mm	H112	400	9,4	4
175 002 002	28	140 x 190 mm	H112	400	12,6	5,5
175 002 091	38	140 x 216 mm	B3 132S	400	16,8	7,5
175 002 087	38	210 x 254 mm	B3 160M	400	29	15

Flange for hollow shaft motor

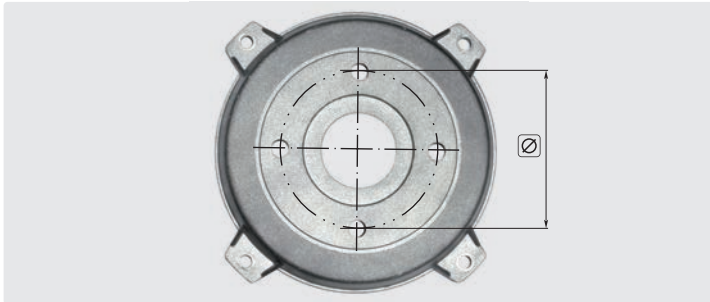

R+M Nr.	TYP	bolt-circle ∅
175 300 306 1	H 100	75 mm
175 300 307 4	H 112	75 mm
175 300 305 1	H 100	87 mm
175 300 305 2	H 112	87 mm

Further versions of Ravel motors are available on request!

Motors with internal flexible joint RVJ Series

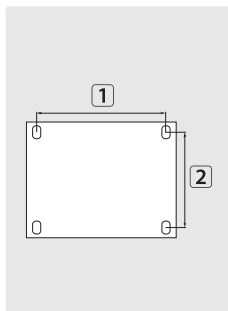
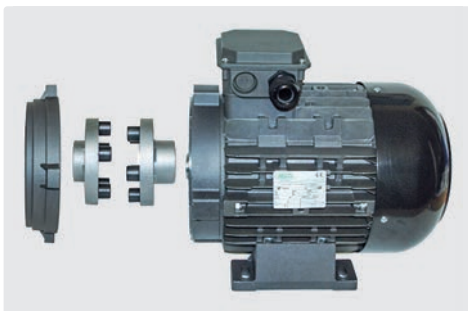

IP54. 1,400 r.p.m.

R+M Nr.	∅	hole size 1 x 2	TYP	V	A	KW
175 002 400	24	140 x 216 mm	H132S	400	15,4	7,5
175 002 401	24	178 x 216 mm	H132M	400	21,3	11
175 002 402	24	178 x 216 mm	H132M	400	17,8	9,2
175 002 570	24	140 x 216 mm	H112	400	12,1	5,5

Pump/motor assignment on page 42

Symbols **M** material **A** ampere **V** voltage **∅** diameter **KW** kilowatt **TYP** type shipment by truck

Motor control easywash365+



Motor control for the operation of motors with 4 - 7.5 kW power at 400 VAC, 50 Hz, IP 65. RAL 7035.
 H x W x D 380 x 380 x 210 mm.
 Supply: 400VAC, 50Hz, 3Ph / N / PE with main switch (cam switch) 25A. Control voltage conditioning 24VDC, 2.5A with backup fuse 2A.
 Motor outlet with power contactor 7.5kW and wide-range motor protection switch 8-32A.
 LOGO small control unit.
 1 operating hours counter (IP 65) and 2 command and signaling devices built into the door

R+M Nr.	
920 001 380	14 kg

Coin box easywash365+ including control box

Coin box easywash365+ including control box



R+M coin box, mechanical, feat. money return, incl. control box, IP 66, RAL 7035 feat. 2 m supply cable with CEE-plug, 16 A, 400 VAC, 50 Hz, 3 PH/N/PE. Control voltage processing 24 VAC, 20 VA with 2 automatic circuit breakers. Motor output with power contactor 7.5 kW, wired to CEE add-on box. Feat. a time relay for pulse stretching 0.05 s - 10 h. Excl. control cable

R+M Nr.	money	coin box	control box
925 513 803	chip (profiled)	260 x 160 x 110	300 x 300 x 155
925 513 805	50 Cent	260 x 160 x 110	300 x 300 x 155
925 513 801	1 €	260 x 160 x 110	300 x 300 x 155
925 513 802	2 €	260 x 160 x 110	300 x 300 x 155

Control cable



5 wires, UV-resistant. Sold by metre.

R+M Nr.	
925 510 001	5 G 1.5 mm ²

Control box easywash365+



Control box, IP 66, RAL 7035. H x W x D 300 x 300 s 155 mm. Feat. 2 m supply cable with CEE-plug 16 A, 400 VAC, 50 Hz, 3 Ph/N/PE. Control voltage processing 24 VAC, 20 VA with 2 automatic circuit breakers. Motor output with power contactor 7.5 kW, wired to CEE add-on box. Feat. a time relay for pulse stretching 0.05 s - 10 h. Excl. control cable

R+M Nr.	
925 510 000	9,6 kg

CEE Plug

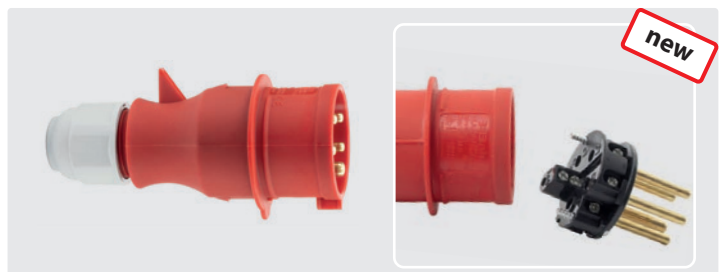

400V / 16A / 3PNE. IP 44. With screw terminals up to a maximum of 2.5 mm²

R+M Nr.
901 338 001

Symbols type weight