

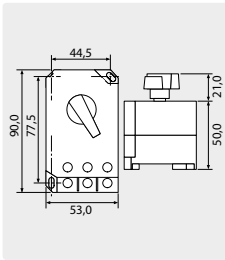

Betriebsstundenzähler	80
Motorschutzschalter	80
Ravel Motoren	81
Thermometer	80
Thermostate	80

**Motorschutzschalter**

Typ OKN



Gehäuse für Typ OKN

R+M Nr.	Schaltbereich
901 516	10,0 - 16,0 A
901 522	16,0 - 22,0 A
901 527	22,0 - 27,0 A

R+M Nr.	(M)
901 540	Kunststoff

Typ OKE 2

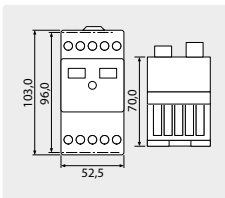

Gehäuse für Typ OKE 2

R+M Nr.	Schaltbereich
901 610	6,3 - 10,0 A
901 616	10,0 - 16,0 A
901 625	16,0 - 25,0 A

R+M Nr.	(M)
901 630	Kunststoff

**Betriebsstundenzähler**



Ausschnitte

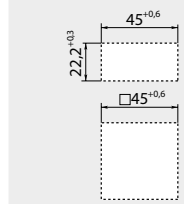

Zähler mit Klemme

R+M Nr.	(V)
915 102 4	24 V ~
915 122 0	230 V ~

**Thermometer**

Thermometer mit Fernkontakt einstellbar

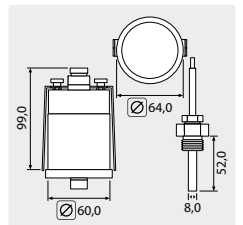

1/2" AG. Kontakt 5 A - 250 V (AC1).  
Temperaturanzeige 0 - 120 °C

R+M Nr.	Schaltbereich	Kapillarrohr
910 20	0 - 80 °C	1.000 mm

**Thermostate**

Emerson 1536

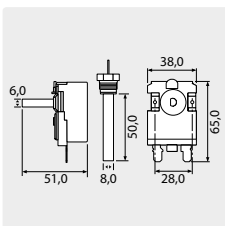

M14 x 1 AG. Kontakt 16 A - 380 V (AC1)

R+M Nr.	Schaltbereich	Kapillarrohr
910 16	0 - 160 °C	1.550 mm

Fühler mit Verschraubung

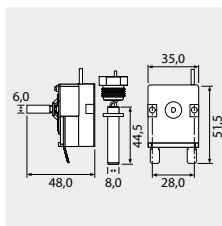

3/8" AG. Kontakt 16 A - 380 V (AC1)

R+M Nr.	Schaltbereich	Kapillarrohr
910 12	30 - 150 °C	1.520 mm
910 13	0 - 152 °C	920 mm

Emerson 8654

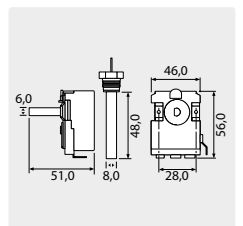

3/8" AG. Kontakt 16 A - 380 V (AC1)

R+M Nr.	Schaltbereich	Kapillarrohr
910 15	30 - 150 °C	1.550 mm

Symbole (M) Material (A) Ampere (V) Volt (W) Watt (Ø) Durchmesser (KW) Kilowatt (TYP) Typ (Spedition)

## Ravel Motoren

### Motor mit Hohlwelle

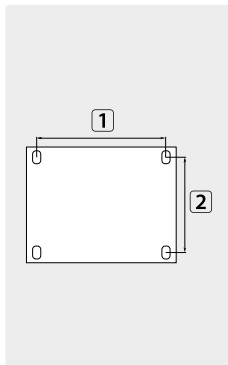

IP54. 1.400 U/min

R+M Nr.	∅	Lochmaß 1 x 2	TYP	V	A	KW
175 001 061	24	140 x 160 mm	H100	400	6,9	3,0
175 001 081	24	140 x 190 mm	H112	400	9,4	4,0
175 001 090	24	140 x 190 mm	H112	400	12,1	5,5
175 001 120	24	140 x 216 mm	H132S	400	15,4	7,5

### Motor mit Vollwelle

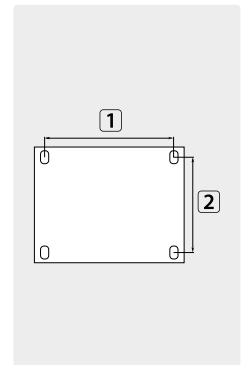

IP54. 1.400 U/min

R+M Nr.	∅	Lochmaß 1 x 2	TYP	V	A	KW
175 002 004	28	140 x 160 mm	H100	400	5,1	2,2
175 002 001	28	140 x 190 mm	H112	400	9,4	4,0
175 002 002	28	140 x 190 mm	H112	400	12,6	5,5
175 002 091	38	140 x 216 mm	H132S	400	16,8	7,5

### Flansch für Hohlwellenmotor

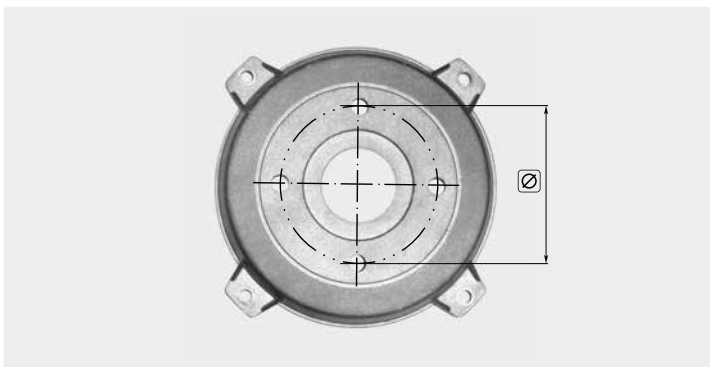

R+M Nr.	TYP	Lochkreis ∅
175 300 306 1	H 100	75 mm
175 300 307 4	H 112	75 mm
175 300 305 1	H 100	87 mm
175 300 305 2	H 112	87 mm

**Weitere Ausführungen der Ravel Motoren  
liefern wir auf Anfrage!**

Pumpen- und Motorenzuordnung finden Sie auf Seite 42

